

HV4-LED 4" ARCHITECTURAL LED DOWNLIGHT

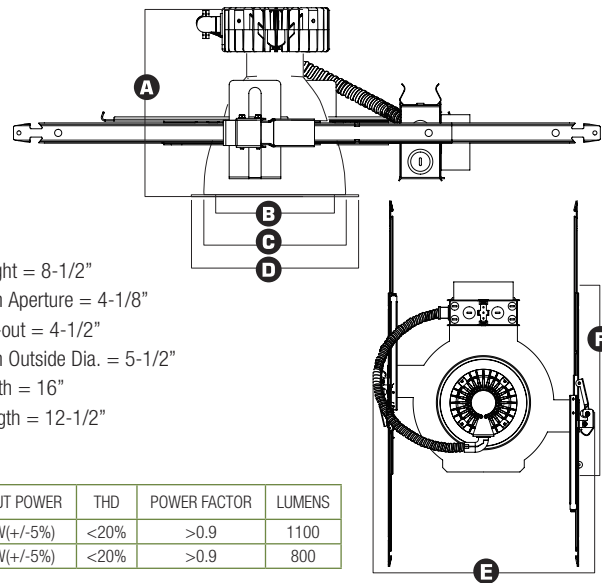

1100 LUMENS

MAXILUME



INPUT VOLT.	INPUT FREQ.	INPUT CUR.	INPUT POWER	THD	POWER FACTOR	LUMENS
120/277	50/60Hz	180mA/76mA	21W(+/-5%)	<20%	>0.9	1100
120/277	50/60Hz	133mA/57mA	16W(+/-5%)	<20%	>0.9	800

DESCRIPTION - 4" LED dedicated Architectural New Construction Downlight with integral LED heat management casting and driver (installed on junction box). Available in 800 lumens (16W) & 1100 lumens (21W). Lighting is smooth and comfortable while using 25% less energy than the common 26W & 32W CFL downlight. Plus the eco-friendly Maxilume LED system features 70% lumen maintenance at 50,000 hours life, with Energy Star and California Title-24 (compliances pending).

FEATURES - Greater light output than a 26W & 32W CFL while consuming less than 16W & 21W of power. Maxilume LED luminaires are ideally suited for use in hospitality, health care, commercial, institutions, retail and other architectural applications.



OPTICS - MAXILUME LED Optilux technology combines unmatched performance with visual comfort. Spun 0.05" thick reflector has been designed to gather the light scattered by the LED chip and shape it into functional beams that minimize brightness and glare, while eliminating lamp image. Proprietary dual level upper and lower reflector design allows for optimum glare control. Elite engineered superior quality, light engine; producing 800 lumens (16W) & 1100 lumens (21W).

PERFORMANCE - Operating system delivers 800 lumens (16W) & 1100 lumens (21W) with a 4100K color temperature. All MAXILUME LED luminaires are rated at 85+ CRI. All LED luminaires are rated and tested to LM-79 and LM-80 standards by an independent laboratory.

THERMAL MANAGEMENT SYSTEM - Using a proprietary coolLED Advanced Thermodynamic Design, Die-cast aluminum housing and heat management system are engineered for extremely long life and service period. Heat sink is attached to top of housing. The LED light engine is attached to the die-cast heat sink and is easily replaceable and upgradable. Life tests have shown the MAXILUME light engine output will be maintained at 70% of initial at 50,000 hours of operation.

DIMMABLE - The MAXILUME LED system is fully dimmable down to 10% of initial light output with a 0-10 Volt dimmer when ordered with the following options (DIM10-120, DIM10-277). Fixtures can be shipped with a Lutron Hi-lume A series Driver which can be dimmed with Lutron Dimming Systems when ordered with the following options (LUTH-120, LUTH-277). Triac & Electronic Low Voltage dimming driver also available when ordered with the following options (DIMTR-120). Consult Factory for details.

MOUNTING FRAME - Die-formed construction for maximum heat dissipation and rust protection.

LED DRIVER/JUNCTION BOX - The LED driver is rated for 50 to 60Hz at 120V /277V input, produces less than 20%THD, and has a power factor between 90% and 100% and is thermally protected for additional safety. MAXILUME's LED driver is installed on the junction box cover so it may be serviced from below the ceiling. UL Listed for through-branch circuit wiring, provided with four 1/2" knockouts, one 3/4" knockout and four Romex knockouts with true pryout slots and strain clamps. Designed for straight through conduit runs.

MOUNTING BRACKET - Constructed from 16 gauge steel and is supplied with C-channels that are adjustable up to 28". Mounting brackets maybe adjusted up to 2-3/4" vertically from inside the housing.

OUR WORD - The MAXILUME LED lighting system is warranted for 5 years. As a system, we stand behind the entire MAXILUME product from housing to bar hangers.

LISTING

c-UL-us / c-ETL-us - listed for Damp location.
 c-UL-us / c-ETL-us - listed for feed Through Wiring.
 LM79 / LM80

DIMMING INFORMATION

DIMTR (Triac & Electronic Low Voltage Dimming)
 DIM10 (0-10V Dimming)
 LUTH (Lutron® Hi-lume® Dimming)

Example: HV4-LED-21W-DIM10-120-FL-30K-LED-4101-CL-WH

TYPE	800 LUMENS	1100 LUMENS	OPTICS	COLOR	EMERGENCY	TRIM TYPE	REFLECTOR/ RING FINISH	DISC		
HV4-LED	<input type="checkbox"/> 16W-DIMTR-120 <input type="checkbox"/> 16W-LUTH-120 <input type="checkbox"/> 16W-LUTH-277 <input type="checkbox"/> 16W-DIM10-120 <input type="checkbox"/> 16W-DIM10-277	<input type="checkbox"/> 21W-LUTH-120 <input type="checkbox"/> 21W-LUTH-277 <input type="checkbox"/> 21W-DIM10-120 <input type="checkbox"/> 21W-DIM10-277	<input type="checkbox"/> FL	<input type="checkbox"/> 30K <input type="checkbox"/> 35K <input type="checkbox"/> 41K	<input type="checkbox"/> EMG-LED	<input type="checkbox"/> LED-4101 <input type="checkbox"/> LED-4102 <input type="checkbox"/> LED-4107 <input type="checkbox"/> LED-4109 <input type="checkbox"/> LED-4110 <input type="checkbox"/> LED-4128 <input type="checkbox"/> LED-4123	<input type="checkbox"/> LED-4112 <input type="checkbox"/> LED-4113 <input type="checkbox"/> LED-4114 <input type="checkbox"/> LED-4115 <input type="checkbox"/> LED-4121 <input type="checkbox"/> LED-4122 <input type="checkbox"/> LED-4125	<input type="checkbox"/> CL-WH <input type="checkbox"/> CL-SCH <input type="checkbox"/> SHZ-SHZ <input type="checkbox"/> SHZ-WH	<input type="checkbox"/> W-WH <input type="checkbox"/> MB-WH <input type="checkbox"/> WT-WH	<input type="checkbox"/> BLUE <input type="checkbox"/> RED <input type="checkbox"/> GREEN <input type="checkbox"/> FROST <input type="checkbox"/> AL <input type="checkbox"/> BZ <input type="checkbox"/> WH



EXAMPLE: LED-4101-CL-WH
LED-4101 - REFLECTOR
REFLECTOR/ RING FINISH:
 CL-WH CL-SCH WT-WH SHZ-WH W-WH SHZ-SHZ MB-WH

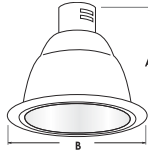

A = 6-1/2"
 B = 5-1/2"
 C = 1"



EXAMPLE: LED-4102-CL-WH
LED-4102 - BAFFLE W/ REFLECTOR
BAFFLE/ RING FINISH:
 W-CL-WH P-CL-WH

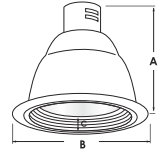

A = 6-1/2"
 B = 5-1/2"
 C = 1"



EXAMPLE: LED-4107-CL-WH
LED-4107 - WALL WASH REFLECTOR
REFLECTOR/ RING FINISH:
 CL-WH CL-SCH WT-WH SHZ-WH W-WH SHZ-SHZ MB-WH

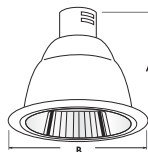

A = 6-1/2"
 B = 5-1/2"
 C = 1"



FOR WET LOCATION

EXAMPLE: LED-4112-CL-WH
LED-4112 - BAFFLE W/ FROSTED GLASS LENS
BAFFLE/ RING FINISH:
 W-WH P-WH

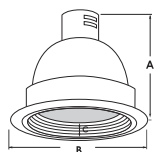

A = 6-7/8"
 B = 5-1/2"
 C = 1"



FOR WET LOCATION

EXAMPLE: LED-4114-CL-WH
LED-4114 - REFLECTOR W/ FROSTED GLASS LENS
REFLECTOR/ RING FINISH:
 CL-WH CL-SCH WT-WH SHZ-WH W-WH SHZ-SHZ MB-WH

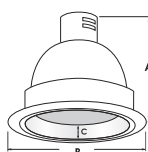

A = 6-1/2"
 B = 5-1/2"
 C = 1"



FOR WET LOCATION

EXAMPLE: LED-4113-CL-WH
LED-4113 - BAFFLE W/ TEMPERED CLEAR GLASS
BAFFLE/ RING FINISH:
 W-WH P-WH

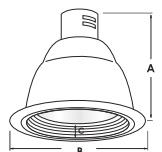

A = 6-1/2"
 B = 5-1/2"
 C = 1"



FOR WET LOCATION

EXAMPLE: LED-4115-CL-WH
LED-4115 - REFLECTOR W/ TEMPERED CLEAR GLASS
REFLECTOR/ RING FINISH:
 CL-WH CL-SCH WT-WH SHZ-WH W-WH SHZ-SHZ MB-WH

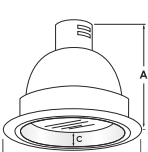

A = 6-7/8"
 B = 5-1/2"
 C = 1"

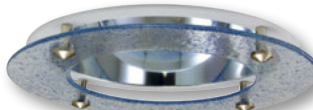

EXAMPLE: LED-4121-CL-WH
LED-4121 - STARDUST DECO RING GLASS
REFLECTOR/ RING FINISH:
 CL-WH CL-SCH WT-WH SHZ-WH W-WH SHZ-SHZ MB-WH

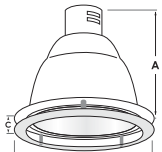

A = 6-1/2"
 B = 5-1/2"
 C = 1-1/4"

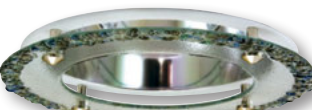

EXAMPLE: LED-4122-CL-WH
LED-4122 - EURO DECO RING GLASS
REFLECTOR/ RING FINISH:
 CL-WH CL-SCH WT-WH SHZ-WH W-WH SHZ-SHZ MB-WH

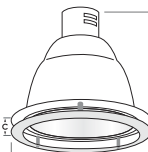

A = 6-1/2"
 B = 5-1/2"
 C = 1-1/4"



EXAMPLE: LED-4123-CL-WH
LED-4123 - PRISM DECO RING GLASS
REFLECTOR/ RING FINISH:
 CL-WH CL-SCH WT-WH SHZ-WH W-WH SHZ-SHZ MB-WH

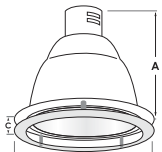

A = 6-1/2"
 B = 5-1/2"
 C = 1-1/4"



EXAMPLE: LED-4109-CL-WH
LED-4109 - DECO GLASS REFLECTOR
REFLECTOR/ RING FINISH:
 CL-WH CL-SCH WT-WH SHZ-WH W-WH SHZ-SHZ MB-WH
GLASS FINISH:
 BLUE, RED, GREEN, FROST

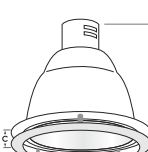

A = 6-1/2"
 B = 5-1/2"
 C = 1-1/4"



EXAMPLE: LED-4110-CL-WH
LED-4110 - DOUBLE RING GLASS
REFLECTOR/ RING FINISH:
 CL-WH CL-SCH WT-WH SHZ-WH W-WH SHZ-SHZ MB-WH
GLASS FINISH:
 BLUE, RED, GREEN, FROST

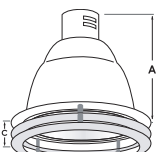

A = 6-1/2"
 B = 5-1/2"
 C = 1-1/2"



ALUMINIUM DISC

EXAMPLE: LED-4128-CL-WH-AL
LED-4128 - DECO GLASS REFLECTOR WITH ALUMINIUM DISC
REFLECTOR FINISH:
 CL-WH CL-SCH WT-WH SHZ-WH W-WH SHZ-SHZ MB-WH
DISC FINISH:
 AL, WH, BZ

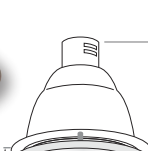

A = 6-1/2"
 B = 5-1/2"
 C = 1-1/4"



EXAMPLE: LED-4125-CL-WH
LED-4125 - CENTRAL ETCHED FLOAT GLASS
REFLECTOR/ RING FINISH:
 CL-WH CL-SCH WT-WH SHZ-WH W-WH SHZ-SHZ MB-WH

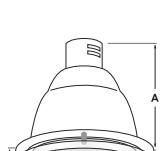

A = 6-1/2"
 B = 5-1/2"
 C = 1-1/4"