

HHR6-LED 6" ARCHITECTURAL HIGH LUMEN LED REMODEL DOWNLIGHT

NEW



MAXILUME



3000 LUMENS

- A** Height = 5-3/4"
- B** Trim Aperture = 6-1/8"
- C** Cut-out = 6-3/4"
- D** Trim Outside Dia. = 7-3/8"
- E** Width = 7-1/2"
- F** Length = 12-3/4"
- G** Flange = 1-1/2"

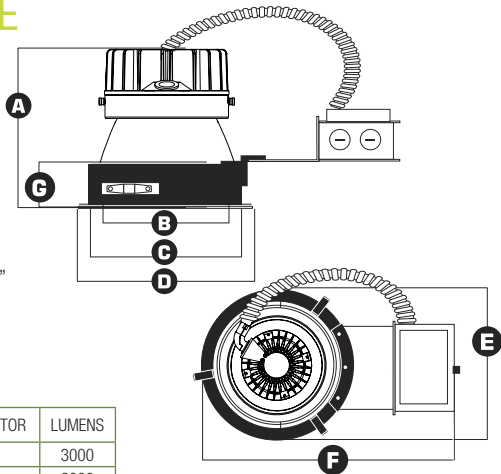

INPUT VOLT.	INPUT FREQ.	INPUT CUR.	INPUT POWER	THD	POWER FACTOR	LUMENS
120/277	50/60Hz	333mA/144mA	40W(+/-5%)	<20%	>0.9	3000
120/277	50/60Hz	266mA/115mA	32W(+/-5%)	<20%	>0.9	2000
120/277	50/60Hz	200mA/86mA	24W(+/-5%)	<20%	>0.9	1200
120/277	50/60Hz	150mA/65mA	16W(+/-5%)	<20%	>0.9	900

DESCRIPTION - 6" LED dedicated Architectural Remodel Downlight with integral LED heat management casting and driver (installed on junction box). Designed for remodel applications in existing plaster or mechanical ceilings. Available in 900 lumens (16W), 1200 lumens (24W), 2000 lumens (32W) & 3000 lumens (40W). Lighting is smooth and comfortable while using 25% less energy than the common CFL downlight. Plus the eco-friendly Maxilume LED system features 70% lumen maintenance at 50,000 hours life, with Energy Star and California Title-24 (compliances pending).

FEATURES - Maxilume LED luminaires are ideally suited for use in hospitality, health care, commercial, institutions, retail and other architectural applications.



OPTICS - MAXILUME LED Optilux technology combines unmatched performance with visual comfort. Spun 0.05" thick reflector has been designed to gather the light scattered by the LED chip and shape it into functional beams that minimize brightness and glare, while eliminating lamp image. Reflector offers a 55 degree cutoff and smooth frost acrylic diffuser distributes light even throughout the workplace.

PERFORMANCE - Operating system delivers 900 lumens (16W), 1200 lumens (24W), 2000 lumens (32W) & 3000 lumens (40W). All MAXILUME LED luminaires are rated at 85+ CRI. Our stringent chip specifications require only those Chips that produce no ultra violet and virtually no infrared. All LED luminaires are rated and tested to LM-79 and LM-80 standards by an independent laboratory.

THERMAL MANAGEMENT SYSTEM - Using a proprietary coolLED Advanced Thermodynamic Design, Die-cast aluminum housing and heat management system are engineered for extremely long life and service period. Heat sink is attached to top of reflector. The LED light engine is attached to the die-cast heat sink and is easily replaceable and upgradable. Without proper heat management, any LED luminaire will fail. Our die-cast system pulls the heat form the LED chip, allowing continued cool operation for years. Life tests have shown the MAXILUME light engine output will be maintained at 70% of initial at 50,000 hours of operation.

DIMMABLE - The MAXILUME LED system is fully dimmable down to 10% of initial light output with a 0-10 Volt dimmer when ordered with the following options (DIM10-120, DIM10-277). Fixtures can be shipped with a Lutron Hi-lume A series Driver which can be dimmed with Lutron Dimming Systems when ordered with the following options (LUTH-120, LUTH-277). Consult Factory for details.

MOUNTING FRAME - Die-formed all construction for maximum heat dissipation and rust protection. For fast and easy installation in existing plaster or mechanical ceiling thickness from 1/2" to 1-3/4". Four remodel clips are easily retractable for fixture removal if necessary.

LED DRIVER/JUNCTION BOX - The LED driver is rated for 50 to 60Hz at 120V /277V input, produces less than 20%THD, and has a power factor between 90% and 100% and is thermally protected for additional safety. MAXILUME's LED driver is installed on the junction box cover so it may be serviced from below the ceiling. UL Listed for through-branch circuit wiring, provided with four 1/2" knockouts, one 3/4" knockout and four Romex knockouts with true pryout slots and strain clamps. Designed for straight through conduit runs.

OUR WORD -The MAXILUME LED lighting system is warranted for 5 years. As a system, we stand behind the entire MAXILUME product.

LISTING

c-UL-us / c-ETL-us - listed for Damp location.
c-UL-us / c-ETL-us - listed for feed Through Wiring.
LM79 / LM80

DIMMING INFORMATION

DIM10 (0-10V Dimming)
LUTH (Lutron® Hi-lume® Dimming)

PATENT NO. D685,118 S

Example: **HHR6-LED-900L-DIM10-120-FL-30K-HH6-6501-CL-WH**

TYPE	16 WATT	24 WATT	32 WATT	40 WATT	OPTICS	COLOR	EMERGENCY	TRIM TYPE	REFLECTOR/ RING FINISH	DISC		
HHR6-LED	<input type="checkbox"/> 900L-LUTH-120 <input type="checkbox"/> 900L-LUTH-277 <input type="checkbox"/> 900L-DIM10-120 <input type="checkbox"/> 900L-DIM10-277	<input type="checkbox"/> 1200L-LUTH-120 <input type="checkbox"/> 1200L-LUTH-277 <input type="checkbox"/> 1200L-DIM10-120 <input type="checkbox"/> 1200L-DIM10-277	<input type="checkbox"/> 2000L-LUTH-120 <input type="checkbox"/> 2000L-LUTH-277 <input type="checkbox"/> 2000L-DIM10-120 <input type="checkbox"/> 2000L-DIM10-277	<input type="checkbox"/> 3000L-LUTH-120 <input type="checkbox"/> 3000L-LUTH-277 <input type="checkbox"/> 3000L-DIM10-120 <input type="checkbox"/> 3000L-DIM10-277	<input type="checkbox"/> FL	<input type="checkbox"/> 30K <input type="checkbox"/> 35K <input type="checkbox"/> 40K	<input type="checkbox"/> EMG-LED	<input type="checkbox"/> HH6-6501 <input type="checkbox"/> HH6-6507 <input type="checkbox"/> HH6-6509 <input type="checkbox"/> HH6-6510 <input type="checkbox"/> HH6-6511 <input type="checkbox"/> HH6-6521	<input type="checkbox"/> HH6-6522 <input type="checkbox"/> HH6-6523 <input type="checkbox"/> HH6-6525 <input type="checkbox"/> HH6-6528 <input type="checkbox"/> HH6-6577	<input type="checkbox"/> CL-WH <input type="checkbox"/> CL-SCH <input type="checkbox"/> SHZ-SHZ <input type="checkbox"/> SHZ-WH	<input type="checkbox"/> W-WH <input type="checkbox"/> MB-WH <input type="checkbox"/> WT-WH	<input type="checkbox"/> BLUE <input type="checkbox"/> RED <input type="checkbox"/> GREEN <input type="checkbox"/> FROST <input type="checkbox"/> AL <input type="checkbox"/> BZ <input type="checkbox"/> WH



FOR
WET
LOCATION

EXAMPLE: HH6-6501-CL-WH
HH6-6501 - REFLECTOR WITH DIFFUSE LENS
REFLECTOR/ RING FINISH:
 CL-WH CL-SCH WT-WH SHZ-WH W-WH SHZ-SHZ MB-WH
 PATENT NO. D685,118 S

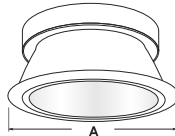

A= 7-1/4"

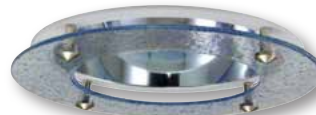

EXAMPLE: HH6-6521-CL-WH
HH6-6521 - STARDUST DECO RING GLASS WITH DIFFUSE LENS
REFLECTOR/ RING FINISH:
 CL-WH CL-SCH WT-WH SHZ-WH W-WH SHZ-SHZ MB-WH

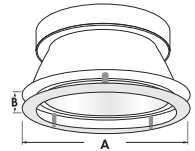

A= 7-1/4"
 B= 1-1/4"



EXAMPLE: HH6-6507-CL-WH
HH6-6507 - WALL WASH REFLECTOR WITH DIFFUSE LENS
REFLECTOR/ RING FINISH:
 CL-WH CL-SCH WT-WH SHZ-WH W-WH SHZ-SHZ MB-WH

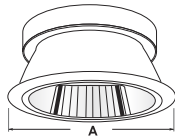

A= 7-1/4"



EXAMPLE: HH6-6523-CL-WH
HH6-6523 - PRISM DECO RING GLASS WITH DIFFUSE LENS
REFLECTOR/ RING FINISH:
 CL-WH CL-SCH WT-WH SHZ-WH W-WH SHZ-SHZ MB-WH

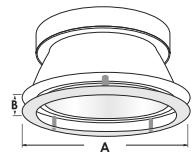

A= 7-1/4"
 B= 1-1/4"



EXAMPLE: HH6-6577-CL-WH
HH6-6577 - DOUBLE WALL WASH REFLECTOR WITH DIFFUSE LENS
REFLECTOR/ RING FINISH:
 CL-WH CL-SCH WT-WH SHZ-WH W-WH SHZ-SHZ MB-WH

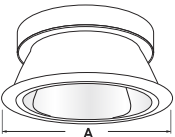

A= 7-1/4"



EXAMPLE: HH6-6522-CL-WH
HH6-6522 - EURO DECO RING GLASS WITH DIFFUSE LENS
REFLECTOR/ RING FINISH:
 CL-WH CL-SCH WT-WH SHZ-WH W-WH SHZ-SHZ MB-WH

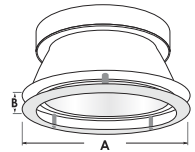

A= 7-1/4"
 B= 1-1/4"



EXAMPLE: HH6-6509-CL-WH
HH6-6509 - DECO GLASS REFLECTOR WITH DIFFUSE LENS
REFLECTOR/ RING FINISH:
 CL-WH CL-SCH WT-WH SHZ-WH W-WH SHZ-SHZ MB-WH
GLASS FINISH:
 BLUE, RED, GREEN, FROST

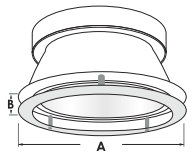

A= 7-1/4"
 B= 1-1/4"



EXAMPLE: HH6-6525-CL-WH
HH6-6525 - CENTRAL ETCHED FLOAT GLASS WITH DIFFUSE LENS
REFLECTOR/ RING FINISH:
 CL-WH CL-SCH WT-WH SHZ-WH W-WH SHZ-SHZ MB-WH

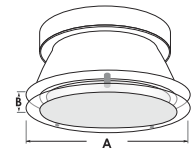

A= 7-1/4"
 B= 1"



EXAMPLE: HH6-6510-CL-WH
HH6-6510 - DOUBLE RING GLASS WITH DIFFUSE LENS
REFLECTOR/ RING FINISH:
 CL-WH CL-SCH WT-WH SHZ-WH W-WH SHZ-SHZ MB-WH
GLASS FINISH:
 BLUE, RED, GREEN, FROST

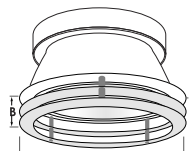

A= 7-1/4"
 B= 1-1/2"



EXAMPLE: HH6-6511-CL-WH
HH6-6511 - TRIPLE RING GLASS WITH DIFFUSE LENS
REFLECTOR/ RING FINISH:
 CL-WH CL-SCH WT-WH SHZ-WH W-WH SHZ-SHZ MB-WH
GLASS FINISH:
 BLUE, RED, GREEN, FROST

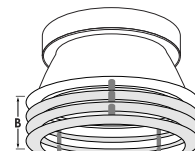

A= 7-1/4"
 B= 2-1/4"



ALUMINIUM
DISC

EXAMPLE: HH6-6528-CL-WH-AL
HH6-6528 - REFLECTOR WITH ALUMINIUM DISC AND DIFFUSE LENS
REFLECTOR FINISH:
 CL-WH CL-SCH WT-WH SHZ-WH W-WH SHZ-SHZ MB-WH
DISC FINISH:
 AL, WH, BZ



HH6-6528-CL-WH-WH



HH6-6528-CL-WH-BZ

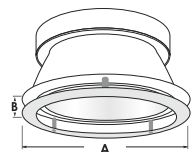

A= 7-1/4"
 B= 1-1/4"

HH6-LED 16W
TOTAL LUMINAIRE EFFICACY = 59.5 LPW

HH6-LED-900L-120-DIM10-FL-40K-HH6-6501-CL-WH TEST NO.: **ELT-HH6-0013**
 INPUT WATTS: **16** LUMENS: **952** CRI: **85+** EFFICACY: **59.5 LPW** CCT: **4000K** SPACING CRITERIA: **0.64**

Candle Power Distribution Curve (Candela)

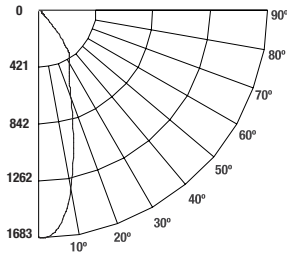

Cone of Light		
4.0'	104.9	2.5'
8.0'	26.2	4.9'
12.0'	11.7	7.4'
16.0'	6.6	9.8'
20.0'	4.2	12.3'
Distance to Plane	Initial Footcandle at Nadir	Beam Diameter

BEAM DIA. MEASURED AT 50% OF NADIR F.C.

Candela Distribution

Q	Q
0	1678
5	1457
15	929
25	528
35	309
45	104
55	16
65	5
75	1
85	0
90	0

Zonal Lumen Summary

Zone	Lumens	%Lamp	%Fixture
0-30	640.0	67.3%	67.3%
0-40	856.8	90.1%	90.2%
0-60	944.7	99.3%	99.4%
0-90	950.3	99.9%	100%

Lumens Per Zone

Zone	Lumens
0-10	135.7
10-20	259.9
20-30	244.4
30-40	216.8
40-50	71.6
50-60	16.3
60-70	4.5
70-80	0.9
80-90	0.2

Luminance (Average Candela/M²)

Angle In Degrees	Average 0°	Average 45°	Average 90°
45°	8069	6401	3400
55°	1562	1555	1597
65°	630	507	288
75°	197	178	160
85°	0	129	22

Coefficients of Utilization - Zonal Cavity Method

Effective Floor Cavity Reflectance 0.20

RCC	80%				70%				50%				30%				10%				0%			
	RW	70%	50%	30%	10%	70%	50%	30%	10%	50%	30%	10%	50%	30%	10%	50%	30%	10%	0%					
0	119	119	119	119	119	116	116	116	116	111	111	111	111	106	106	106	102	102	102	100				
1	113	111	108	106	111	109	106	104	105	103	101	101	101	99	98	97	96	96	95	93				
2	108	103	99	96	106	101	98	95	98	95	92	95	93	90	92	90	89	89	87	87				
3	102	96	91	87	100	95	90	86	92	88	85	90	86	84	87	85	82	81	81	81				
4	97	90	84	80	95	89	84	80	86	82	79	84	81	78	83	79	77	75	75	75				
5	92	84	78	74	91	83	78	74	81	77	73	80	76	72	78	75	72	70	70	70				
6	88	79	73	69	86	78	73	69	77	72	68	75	71	68	74	70	67	66	66	66				
7	84	74	68	64	82	74	68	64	72	67	64	71	67	63	70	66	63	62	62	62				
8	80	70	64	60	78	70	64	60	69	63	60	68	63	60	67	62	59	58	58	58				
9	76	66	61	57	75	66	60	57	65	60	56	64	60	56	63	59	56	55	55	55				
10	73	63	57	53	72	63	57	53	62	57	53	61	56	53	60	56	53	52	52	52				

RC - Ceiling Cavity Reflectance RW - Wall Reflectance

*Note: Lumen output and input wattage vary depending on driver and reflector type. Listed values may vary +/-10%.

HH6-LED 24W
TOTAL LUMINAIRE EFFICACY = 53.5 LPW

HH6-LED-1200L-120-DIM10-FL-40K-HH6-6501 CL-WH TEST NO.: **ELT-HH6-0014**
 INPUT WATTS: **24** LUMENS: **1284** CRI: **85+** EFFICACY: **53.5 LPW** CCT: **4000K** SPACING CRITERIA: **0.64**

Candle Power Distribution Curve (Candela)

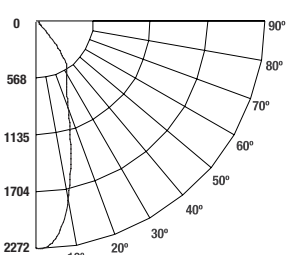

Cone of Light		
4.0'	141.6	2.5'
8.0'	35.4	4.9'
12.0'	15.7	7.4'
16.0'	8.9	9.8'
20.0'	5.7	12.3'
Distance to Plane	Initial Footcandle at Nadir	Beam Diameter

BEAM DIA. MEASURED AT 50% OF NADIR F.C.

Candela Distribution

Q	Q
0	2266
5	1968
15	1255
25	713
35	417
45	141
55	22
65	11
75	2
85	0
90	0

Zonal Lumen Summary

Zone	Lumens	%Lamp	%Fixture
0-30	864.0	67.3%	67.3%
0-40	1,156.7	90.2%	90.2%
0-60	1,275.4	99.4%	99.4%
0-90	1,282.9	100%	100%

Lumens Per Zone

Zone	Lumens
0-10	183.2
10-20	350.9
20-30	329.9
30-40	292.6
40-50	96.6
50-60	22.1
60-70	6.0
70-80	1.2
80-90	0.3

Luminance (Average Candela/M²)

Angle In Degrees	Average 0°	Average 45°	Average 90°
45°	10893	8642	4590
55°	2019	2099	2157
65°	851	685	388
75°	266	240	216
85°	0	174	30

Coefficients of Utilization - Zonal Cavity Method

Effective Floor Cavity Reflectance 0.20

RCC	80%				70%				50%				30%				10%				0%			
	RW	70%	50%	30%	10%	70%	50%	30%	10%	50%	30%	10%	50%	30%	10%	50%	30%	10%	0%					
0	119	119	119	119	119	116	116	116	116	111	111	111	106	106	106	102	102	102	100					
1	114	111	108	106	111	109	106	104	105	103	101	101	101	99	98	97	96	95	94					
2	108	103	99	96	106	101	98	95	98	95	93	95	93	91	92	90	89	87	87					
3	103	96	91	87	101	95	90	86	92	88	85	90	86	84	87	85	82	81	81					
4	97	90	84	80	96	89	84	80	87	82	79	85	81	78	83	80	77	75	75					
5	92	84	78	74	91	83	78	74	81	77	73	80	76	72	78	75	72	70	70					
6	88	79	73	69	86	78	73	69	77	72	68	75	71	68	74	70	67	66	66					
7	84	74	68	64	82	74	68	64	73	67	64	71	67	63	70	66	63	62	62					
8	80	70	64	60	78	70	64	60	69	64	60	68	63	60	67	62	59	58	58					
9	76	66	61	57	75	66	60	57	65	60	56	64	60	56	63	59	56	55	55					
10	73	63	57	54	72	63	57	53	62	57	53	61	56	53	60	56	53	52	52					

RC - Ceiling Cavity Reflectance RW - Wall Reflectance

*Note: Lumen output and input wattage vary depending on driver and reflector type. Listed values may vary +/-10%.

HH6-LED 32W

TOTAL LUMINAIRE EFFICACY = 62.6 LPW

HH6-LED-2000L-120-DIM10-FL-40K-HH6-6501-CL-WH

TEST NO.: **ELT-HH6-0015**

INPUT WATTS: **32** LUMENS: **2002**

CRI: **85+**

EFFICACY: **62.6 LPW**

CCT: **4000K**

SPACING CRITERIA: **0.64**

Candle Power Distribution Curve (Candela)

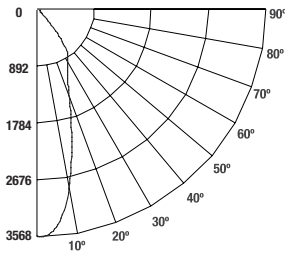

Cone of Light		
4.0'	222.4	2.5'
8.0'	55.6	4.9'
12.0'	24.7	7.4'
16.0'	13.9	9.8'
20.0'	8.9	12.3'
Distance to Plane	Initial Footcandles at Nadir	Beam Diameter

BEAM DIA. MEASURED AT 50% OF NADIR F.C.

*Note: Lumen output and input wattage vary depending on driver and reflector type. Listed values may vary +/-10%.

Candela Distribution

Q	Candela
0	3558
5	3090
15	1971
25	1120
35	655
45	221
55	35
65	10
75	2
85	0
90	0

Zonal Lumen Summary

Zone	Lumens	%Lamp	%Fixture
0-30	1,356.9	67.3%	67.3%
0-40	1,816.4	90.1%	90.2%
0-60	2,002.8	99.4%	99.4%
0-90	2,014.7	100%	100%

Lumens Per Zone

Zone	Lumens
0-10	287.7
10-20	551.0
20-30	518.1
30-40	459.6
40-50	151.8
50-60	34.7
60-70	9.5
70-80	1.9
80-90	0.5

Luminance (Average Candela/M²)

Angle In Degrees	Average 0°	Average 45°	Average 90°
45°	17106	13571	7209
55°	3312	3296	3387
65°	1337	1076	610
75°	417	377	339
85°	0	273	47

Coefficients of Utilization - Zonal Cavity Method

Effective Floor Cavity Reflectance 0.20

RCC	80%			70%			50%			30%			10%			0%		
	RW	70%	50%	30%	10%	0%	70%	50%	30%	10%	0%	50%	30%	10%	50%	30%	10%	0%
0	119	119	119	119	116	116	116	111	111	111	106	106	106	102	102	102	100	100
1	114	111	108	106	111	109	106	104	105	103	101	101	99	98	97	96	95	94
2	108	103	99	96	106	101	98	95	98	95	93	95	93	91	92	90	89	87
3	102	96	91	87	101	95	90	86	92	88	85	90	86	84	87	85	82	81
4	97	90	84	80	96	89	84	80	87	82	79	85	81	78	83	79	77	75
5	92	84	78	74	91	83	78	74	81	77	73	80	76	72	78	75	72	70
6	88	79	73	69	86	78	73	69	77	72	68	75	71	68	74	70	67	66
7	84	74	68	64	82	74	68	64	72	67	64	71	67	63	70	66	63	62
8	80	70	64	60	78	70	64	60	69	64	60	68	63	60	67	62	59	58
9	76	66	61	57	75	66	60	57	65	60	56	64	60	56	63	59	56	55
10	73	63	57	54	72	63	57	53	62	57	53	61	56	53	60	56	53	52

RC - Ceiling Cavity Reflectance RW - Wall Reflectance

HH6-LED 40W

TOTAL LUMINAIRE EFFICACY = 75.8 LPW

HH6-LED-3000L-120-DIM10-FL-40K-HH6-6501-CL-WH

TEST NO.: **ELT-HH6-0016**

INPUT WATTS: **40** LUMENS: **3032**

CRI: **85+**

EFFICACY: **75.8 LPW**

CCT: **4000K**

SPACING CRITERIA: **0.64**

Candle Power Distribution Curve (Candela)

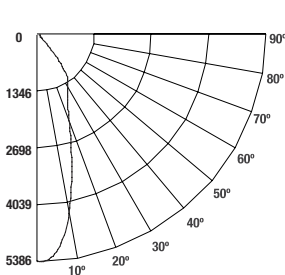

Cone of Light		
4.0'	335.7	2.5'
8.0'	83.9	4.9'
12.0'	37.3	7.4'
16.0'	21.0	9.8'
20.0'	13.4	12.3'
Distance to Plane	Initial Footcandles at Nadir	Beam Diameter

BEAM DIA. MEASURED AT 50% OF NADIR F.C.

*Note: Lumen output and input wattage vary depending on driver and reflector type. Listed values may vary +/-10%.

Candela Distribution

Q	Candela
0	5371
5	4664
15	2974
25	1690
35	988
45	333
55	52
65	16
75	3
85	0
90	0

Zonal Lumen Summary

Zone	Lumens	%Lamp	%Fixture
0-30	2,048.1	67.3%	67.3%
0-40	2,741.8	90.2%	90.2%
0-60	3,023.1	99.4%	99.4%
0-90	3,041.1	100%	100%

Lumens Per Zone

Zone	Lumens
0-10	434.3
10-20	831.7
20-30	782.1
30-40	693.7
40-50	229.1
50-60	52.3
60-70	14.3
70-80	2.9
80-90	0.7

Luminance (Average Candela/M²)

Angle In Degrees	Average 0°	Average 45°	Average 90°
45°	25820	20484	10881
55°	4999	4974	5112
65°	2018	1624	921
75°	630	569	511
85°	0	412	70

Coefficients of Utilization - Zonal Cavity Method

Effective Floor Cavity Reflectance 0.20

RCC	80%			70%			50%			30%			10%			0%		
	RW	70%	50%	30%	10%	0%	70%	50%	30%	10%	0%	50%	30%	10%	50%	30%	10%	0%
0	119	119	119	119	116	116	116	111	111	111	106	106	106	102	102	102	100	100
1	114	111	108	106	111	109	106	104	105	103	101	101	99	98	97	96	95	94
2	108	103	99	96	106	101	98	95	98	95	92	95	93	91	92	90	89	87
3	102	96	91	87	100	95	90	86	92	88	85	90	86	84	87	85	82	81
4	97	90	84	80	96	89	84	80	87	82	79	85	81	78	83	79	77	75
5	92	84	78	74	91	83	78	74	81	77	73	80	76	72	78	75	72	70
6	88	79	73	69	86	78	73	69	77	72	68	75	71	68	74	70	67	66
7	84	74	68	64	82	74	68	64	72	67	64	71	67	63	70	66	63	62
8	80	70	64	60	78	70	64	60	69	64	60	68	63	60	67	62	59	58
9	76	66	61	57	75	66	60	57	65	60	56	64	60	56	63	59	56	55
10	73	63	57	54	72	63	57	53	62	57	53	61	56	53	60	56	53	52

RC - Ceiling Cavity Reflectance RW - Wall Reflectance